

5. Maintenance and Checks

Bulb life

Total irradiation time of the bulb is approximately 160 hours. However, this is just a rough estimate and cannot be guaranteed. Bulb life varies depending on the conditions of use (handling of the unit and lamp, frequency and duration of each curing, etc).

Replacement of lamp

1. Turn off and unplug the unit. Leave for a minimum of 10 minutes and make sure that the unit has completely cooled down.
2. Pull up the cover on top as mentioned under section "3. Installation and Connection" - "Installation of lamp".
3. Pull up the lamp holder lever as directed by arrow (①) and remove the lamp (②). Detach the socket from the lamp (③).

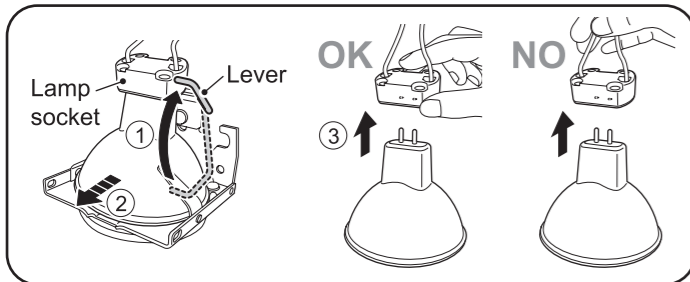

Note Hold the socket firmly and pull out carefully from the lamp.

4. Place the new lamp and replace the cover as mentioned in procedures 4 - 6 under section "3. Installation and Connection" - "Installation of lamp".

Note Use only designated lamp. (refer to "9. Consumables")

Replacement of fuse

1. Turn off and unplug the unit.
2. Remove the screw at the back of the unit using a falthread screwdriver.
3. Replace old fuses with new ones.

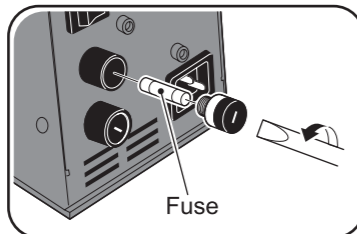

Note Please refer to "8. Specifications" for the specification of fuse.

4. Replace the screw onto the fuse case in the reverse order of procedure 2.

Maintenance

Do not use organic solvents including benzene and thinner. Dilute a neutral detergent with water and soak a soft cloth with it. Squeeze out the excess detergent from the cloth and gently wipe the unit.

6. Troubleshooting

Problem	Cause	Solution
Pilot lamp does not light up after power switch is turned on.	Blowout of fuse.	Replace with new fuse.
Halogen lamp does not work even though the One-touch switch is pressed with the pilot lamp on.	Socket is not connected properly to the lamp.	Attach socket properly to the lamp.
	Lamp filament is burnt out.	Replace with a new lamp.
	Improperly placed cover.	Place the cover properly.

7. EU Declaration of Conformity

Manufacturer : SHOFU INC.

Head Office
11 Kamitakamatsu-cho, Fukuine, Higashiyama-ku,
Kyoto 605-0983, Japan

Product : Sublite V

The product Sublite V has been built and tested according to the following relevant EU norms and specifications.

Standard :

- Safety : EN61010-1:2010
- EMC : EN61326-1:2006, EN55011:2007+A2:2007(Group 1 Class A)
EN61000-3-2:2006, EN61000-3-3:1995+A1:2001+A2:2005
EN61326-1:2006(Table 2)

EC Directive :

- Safety : LVD 2006/95/EC
- EMC : EMC 2004/108/EC

Authorized representative in EU :

SHOFU Dental GmbH
Am Brüll 17, 40878 Ratingen, Germany
Telephone : +49(0)21 02/86 64-0
Faximile : +49(0)21 02/86 64-65
Homepage : www.shofu.de

8. Specifications

Model	SSBLV-1
Rated supply voltage ...	AC100 - 127V/200 - 240V±10%, 50/60Hz
Power supply	350VA
Lamp	JCR 110V 150W/S
Fuse	Time-lag, AC250V 1.6A L x 2
Dimensions	W112 × D210 × H252mm / W4.4 × D8.3 × H9.9in
Weight.....	Approx. 2.5kg / Approx. 5.5lb
Operating conditions ...	Temperature : 5 - 40°C / 41-104°F
	Humidity : 30 - 80%
	Altitude : Up to 2,000m
	Pollution degree : 2
	Overvoltage category : II
	Indoor use only
Storage conditions	Temperature : 0 - 40°C / 32-104°F
	Humidity : 10 - 85%

* Specifications above may be changed without prior notice due to product improvement.

9. Consumables

Halogen lamp (JCR 110V 150W/S)

10. Warranty

This product has undergone strict inspection before shipping. Should this product, under normal operating conditions, prove defective within one year from the date of purchase, it will be repaired free of charge, except for the halogen lamp.



Manufacturer
SHOFU INC. 11 Kamitakamatsu-cho, Fukuine, Higashiyama-ku, Kyoto 605-0983, Japan
SHOFU DENTAL CORPORATION 1225 Stone Drive, San Marcos, California 92078-4059, USA
SHOFU DENTAL GERMANY GmbH Am Brüll 17, 40878 Ratingen, Germany
SHOFU DENTAL TRADING (SHANGHAI) CO., LTD. No. 845 Jiye Road, Sheshan Industrial Park, Songjiang, Shanghai 201602, China
SHOFU DENTAL ASIA-PACIFIC PTE. LTD. 10 Science Park Road, #03-12, The Alpha, Science Park II, Singapore 117684

Sublite V



Light curing sub-unit for dental laboratory

Instructions for Use

SHOFU INC.



03:2014-03
16562

Introduction

Thank you for purchasing Sublite V. The instructions mentioned below provide necessary information on successful operation, daily maintenance and safe use of this unit. Please read the instructions carefully before use to attain maximum benefits during function and ensure durability of this unit. Kindly keep this manual for your future reference.

Notes

- No part of this document may be copied or reproduced in any form by any means.
- Some information in this document might become inconsistent with the product due to product improvement.
- The information in this document is subject to change without prior notice.
- All relevant issues have been considered in the preparation of this document. However, should you notice an omission or any questionable item in this document, please feel free to notify SHOFU.
- In case of missing pages or disorder, please contact our local dealer for replacement.
- We will repair and replace the main unit and its system in case of trouble within the warranty period. However, we do not assume any responsibility for subsequent damages arising from the failure of the unit.

Indications

Temporary curing of light-cured indirect composite resin, to retain the desired shape during the fabrication of the restoration.

- * The temporarily cured material has to be cured in the light-curing unit designated for each material to ensure optimal polymerization.
- * The Sublite V is not recommended for light-curing Opaque material.

1. Safety information

It is important to understand the following terms to use this product safely.

Warning and Caution

Important safety information is mentioned under "Warning" or "Caution". Definitions are as follows.

Warning	Indicates a potentially hazardous situation which, if not avoided, could result in serious injury or death.
Caution	Indicates a potentially hazardous situation which, if not avoided, may result in minor / moderate injury or damage of property.

The sign below indicates the following potential hazard.

	Indicates a potentially hazardous situation which, if not avoided, may result in burns.
--	---

Notes and Signs

Other notes and signs used in this manual are shown below.

- Note** Indicates that potential malfunctions may occur if the description is ignored.
- Reference** Supplementary information to facilitate better operation.

Installation and Connection

Warning

- Ensure earthing of terminal outlet and power socket. Electricity leak in the main unit might cause electric shock or fire.
- Always use the provided power cord. Using other cords may cause fire.
- Keep away from sources of ignition to avoid fire or explosion.
- Protect from liquid or high humidity to avoid electrical leak, electric shock or fire.

Caution

- Use within the rated supply voltage to avoid fire or electric shock.
- Use one outlet supplying necessary power exclusively for this unit to avoid overloading the circuit. If power supply is insufficient, the outlet will overheat and might result in fire or electric shock.
- Use at room temperature (5 - 40°C / 41-104°F). Ensure that there is no condensation to avoid short circuit or electric shock.
- Do not use in a dusty area. Ensure that power plug is free of dust and connected securely to the outlet. Dust particles if exposed to electric sparks may cause fire.
- Place the unit on a flat and sturdy table that withstands the weight of the unit. Leave a gap of at least 20cm (8in) from all sides and 30cm (12in) from the top of the machine. If adequate space is not provided for release of heat, the machine will overheat leading to smoke or fire.

Operation

Warning

- Never touch the power plug with wet hands to avoid electric shock.
- Never expose the unit to any liquid to avoid electric shock, electric leak or fire.

Caution

- Always follow the Directions for Use in these Instructions for Use. If not used properly according to the Directions for Use, protective performance of the unit might be ruined.
- Do not look at the light directly to avoid harm to the eyes.
- Unplug the power cord gently, avoid grasping the cord as it may damage the insulation resulting in electric shock, injury or burn.
- Never damage / reprocess or apply unnecessary force on the power cord or place any heavy objects on the power cord. A damaged power cord may cause an electric shock or fire.
- Never fail to turn off the unit after cooling down the unit with the fan for 3 minutes. Unplug the unit if it is not to be used for a long period to avoid injuries or skin burn.
- Do not touch the heat-resisting-filter located in front of the lamp and its surrounding area, to avoid injury or burn.
- Do not place hands too close to the area where light is intense, to avoid burn.
- Always operate with heat-resisting-filter in place. Do not use broken glass filter as it can not prevent the lamp glass from scattering when it breaks for some reason and also be harmful to the eyes due to exposure to light.
- Do not block, touch or stop the cooling fan. The interior of the unit will not be adequately cooled and may create a fire hazard. Do not touch or insert objects into the fan while in operation to avoid injury.
- In case of any smoke or any unusual smell, immediately discontinue use to avoid electric shock or fire.
- Do not use the unit if it falls off the table. Halogen lamp, and Light guard etc might be damaged which can cause injury. This may also result in smoke or fire.
- Do not use for any purpose other than specifically outlined in the "Indications" in these Instructions for Use.

Maintenance and Checks

Warning

- When checking, cleaning or replacing lamp and fuses, always turn off and unplug the unit. Leave the unit off for at least 10 minutes to ensure that the unit has cooled completely to avoid electric shock, burn, fire or injury due to damage to lamp.
- Never disassemble, repair or overhaul except to replace lamp and fuse. Improper assembly or repair may cause the unit to malfunction and pose the risk of electric shock or fire.
- Use only designated lamp and fuses. Using lamp and fuses other than those specified for the unit may cause injury, electric shock or fire due to malfunction of the lamp or circuit.
- Hold the socket firmly while installing or replacing the lamp to avoid electric shock or fire.
- Attach the lamps securely. If not secured properly, it may cause heat or fire.

2. Package and Part names

Main unit

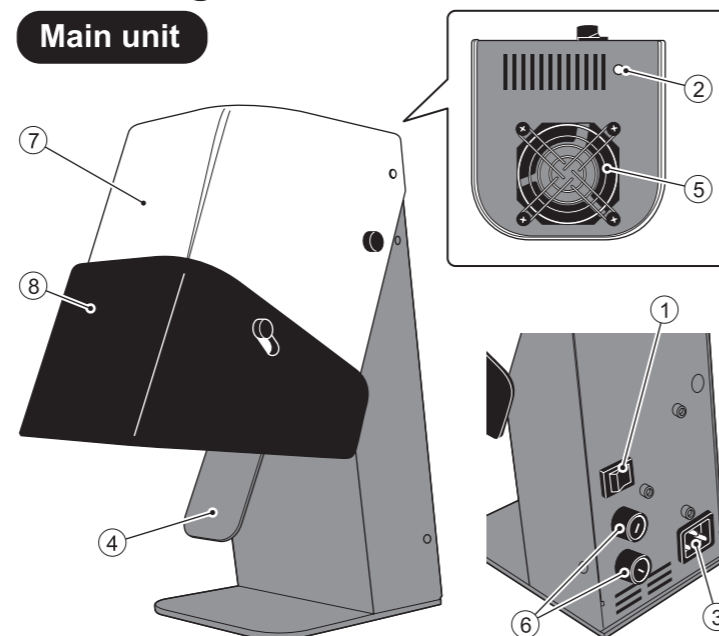

- ① Main switch (I:ON O:OFF)
- ② Pilot lamp
- ③ Inlet
- ④ One-touch switch
- ⑤ Cooling fan
- ⑥ Fuse case
- ⑦ Cover
- ⑧ Light guard

Accessories

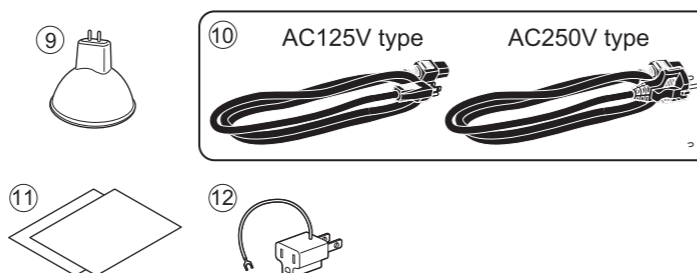

- ⑨ Halogen lamp
 - ⑩ Power cord (for AC125V model or AC250V model)
 - ⑪ Instructions for Use
 - ⑫ Adapter
- * ⑩ Power cord : Only one power cord (exclusively designed for either AC125V model or AC250V model) is provided.
- * ⑫ Adapter : For use in Japan only.

3. Installation and Connection

Location

- Place the unit in a clean, dry, well-ventilated room to ensure safe use of the unit.
- The optimal environment (temperature and humidity) is specified under Section "8. Specifications" of the machine.
- Place the unit on a flat and sturdy table. Leave a gap of at least 20cm (8in) from all sides and 30cm (12in) from the top of the machine. Do not place any objects around the inlet.

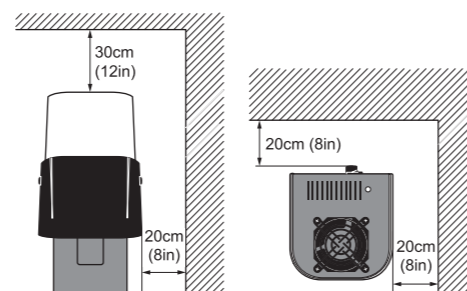

Installation of lamp

1. Turn off and unplug the unit.
2. Loosen the 2 screws that fix the Cover (①). Gently pull up the Cover as directed by arrow (②).
3. Remove protective cushion from the lamp socket.
4. Carefully insert the lamp terminal into the socket (③).
5. Pull down the lever (④) and insert the lamp (⑤) as directed by arrows.

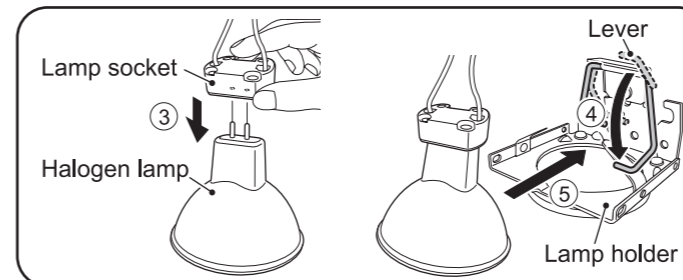
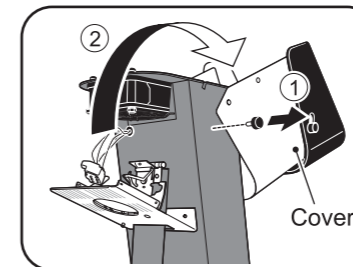

- Note**
- Use only designated lamp. Use of lamp other than the one designed specifically for Sublite V may result in insufficient curing, filament burn-out or explosion of bulb.
 - Do not touch the bulb and the mirror with bare hands to avoid adhesion of sebum. If the bulb is contaminated with any type of oil or sebum, the bulb might explode due to high temperature while the unit is being operated.
 - Handle the lamp carefully. Any direct impact including a fall will shorten the life of the lamp.

6. Refix the cover with the two screws.

Connection of power cord

1. Make sure that the power outlet is compatible with the unit (refer to Table 1).
2. Turn off the unit.
3. Insert the connector into the inlet at the back of the body and plug the power cord into a ground terminal outlet.

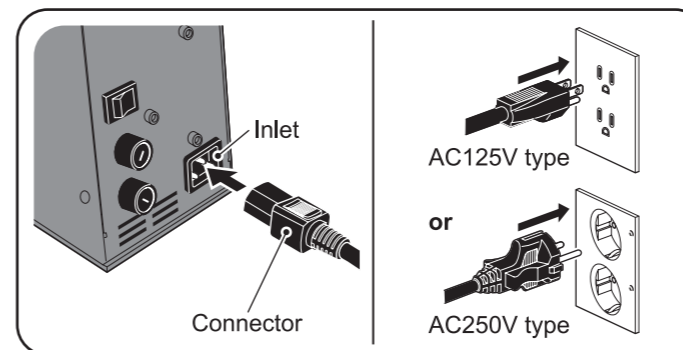

- Note** The adapter provided is for use in Japan only.

Table 1. Supply voltage and power cord for each model

Model	Supply voltage	Power cord
AC125V model	AC110 - 120V	AC125V type
	AC127V	*
AC250V model	AC200 - 240V	AC250V type

* When using with AC127V, prepare compatible power cord.

4. Directions for Use

Basic operation

1. Turn on the unit (①).
The pilot lamp is on and cooling fan starts operating.
2. Hold the restoration and gently press the One-touch switch as shown in the figure (②).
Bulb lights up slowly (soft start function) and light-cures for approximately 5 seconds.
Reference To light-cure for over 5 seconds, keep pressing the switch. However, irradiation can continue for approximately 20 seconds, after which the lamp switches off automatically.

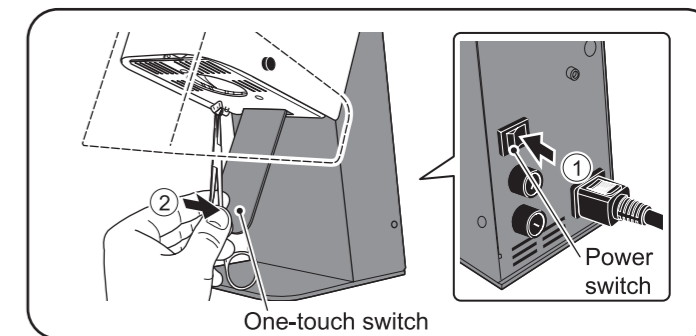

3. Position restoration within the curing area. Check the position through the Light guard.
Note Never position the restoration too close to the bulb to avoid burns and under curing due to adhesion of resin to the heat-resisting-filter.
4. Remove the restoration from the curing area and release switch after temporary curing is complete.

Reference Kindly refer to the recommended duration for temporary light-curing of SHOFU's SOLIDEX and CERAMAGE.

Table 2. Recommended duration for temporary curing (SOLIDEX and CERAMAGE)

Operation	Time
Temporary light-curing of C&B composite resin (Cervical, Body, Incisal etc)	5 seconds or more
Temporary light-curing of flowable composite resin	5 seconds or more
Temporary light-curing of stain	5 seconds or more

5. Leave the fan running for 3 minutes after light-curing, to ensure that the unit cools down completely before switching off the unit.

Adjustment of Light guard

1. Loosen the two screws that fix the Light guard (①).
2. Adjust the position of Light guard as directed by the arrow (②).
3. Refix the screws at the desired position.

